

K SERIE ○



cranes without compromise

FASSI

CRANES WITHOUT COMPROMISE

F65AK

.21

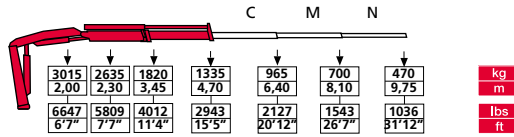

.22

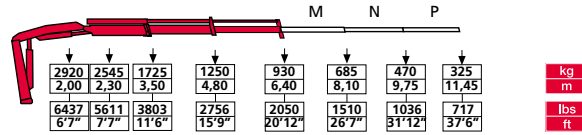

	tm	lbs.ft	m	ft	°	kNm	lbs.ft	Mpa	psi	l/min	gal/min	oil	l	gal	kg	lbs
F65AK.21	6,30	45568	4,85	15'11"	370	9,8	7228	26,0	3771	20	5,3	60	16	740	1631	
F65AK.22	6,05	43760	6,50	21'41"	370	9,8	7228	26,0	3771	20	5,3	60	16	820	1808	

F80AK

.21

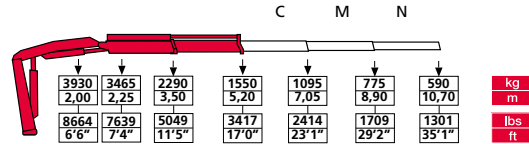

.22

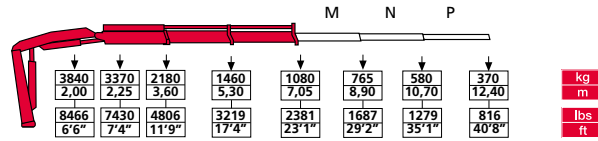

	tm	lbs.ft	m	ft	°	kNm	lbs.ft	Mpa	psi	l/min	gal/min	oil	l	gal	kg	lbs
F80AK.21	8,05	58226	5,40	17'9"	370	11,7	8630	30,0	4351	20	5,3	60	16	910	2006	
F80AK.22	7,85	56779	7,20	23'7"	370	11,7	8630	30,0	4351	20	5,3	60	16	1015	2238	

F95AK

.21

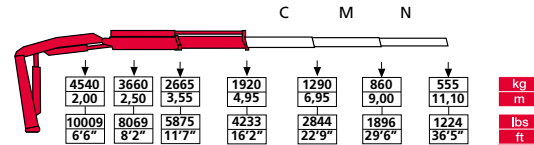

.22

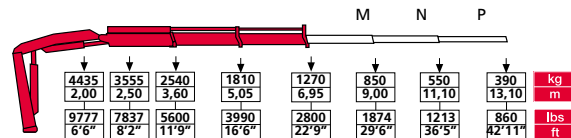

	tm	lbs.ft	m	ft	°	kNm	lbs.ft	Mpa	psi	l/min	gal/min	oil	l	gal	kg	lbs
F95AK.21	9,50	68714	5,10	16'9"	390	17,7	13055	29,0	4206	25	6,6	60	16	1090	2403	
F95AK.22	9,15	66182	7,10	23'4"	390	17,7	13055	29,0	4206	25	6,6	60	16	1190	2624	

F110AK

.21

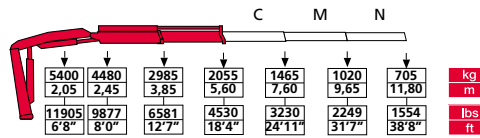

.22

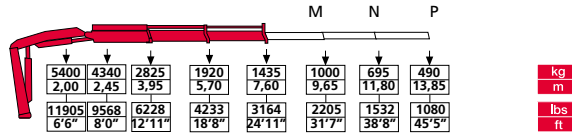

.23

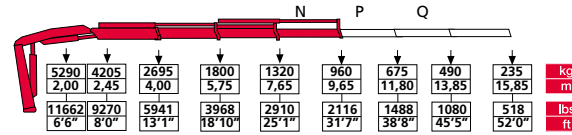

	tm lbs.ft	m ft	°	kNm lbs.ft	Mpa psi	l/min gal/min	l gal	kg lbs
F110AK.21	11,50 83180	5,80 19'0"	390	17,6 12981	30,0 4351	30 7,9	70 18	1440 3175
F110AK.22	11,15 80648	7,80 25'7"	390	17,6 12981	30,0 4351	30 7,9	70 18	1580 3483
F110AK.23	10,80 78116	9,85 32'4"	390	17,6 12981	30,0 4351	30 7,9	70 18	1710 3770

F130AK

.21

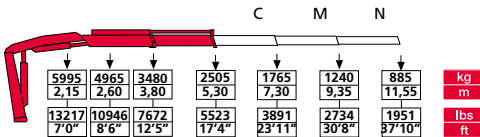

.22

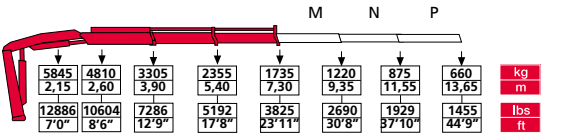

.23

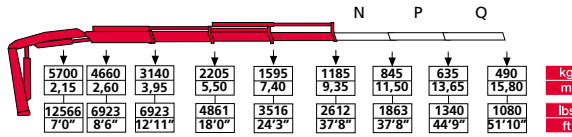

	tm lbs.ft	m ft	°	kNm lbs.ft	Mpa psi	l/min gal/min	l gal	kg lbs
F130AK.21	13,30 96199	5,55 18'3"	390	21,5 15858	28,5 4134	40 10,6	90 24	1635 3605
F130AK.22	12,90 93306	7,50 24'7"	390	21,5 15858	28,5 4134	40 10,6	90 24	1795 3957
F130AK.23	12,40 89689	9,60 31'6"	390	21,5 15858	28,5 4134	40 10,6	90 24	1950 4299

F150AK

.21

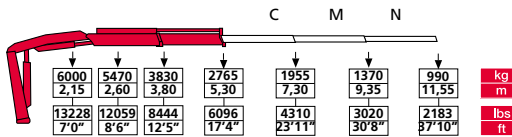

.22

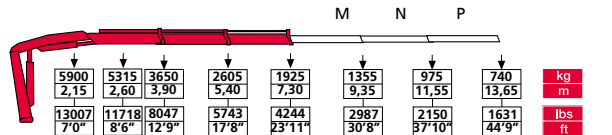

.23

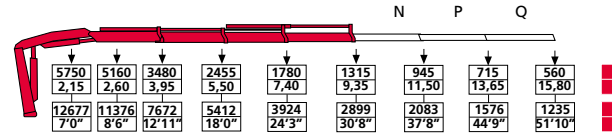

	tm lbs.ft	m ft	°	kNm lbs.ft	Mpa psi	l/min gal/min	l gal	kg lbs
F150AK.21	14,65 105963	5,55 18'3"	390	21,5 15858	29,0 4206	40 10,6	90 24	1645 3627
F150AK.22	14,25 103070	7,50 24'7"	390	21,5 15858	29,0 4206	40 10,6	90 24	1805 3979
F150AK.23	13,75 99454	9,60 31'6"	390	21,5 15858	29,0 4206	40 10,6	90 24	1960 4321

K SERIE

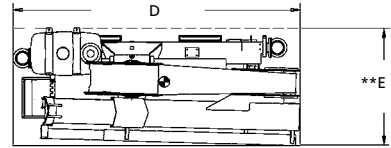
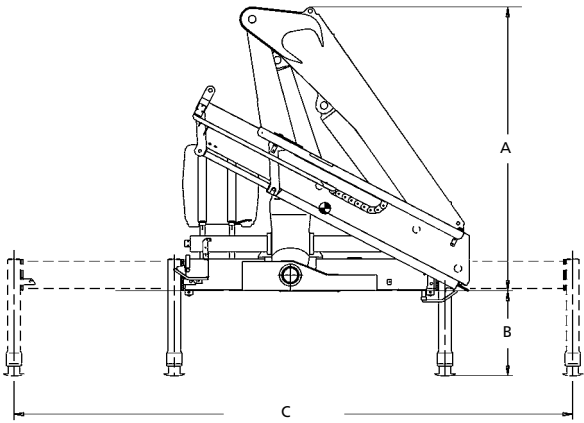

**E = con tubazioni supplementari
avec tuyauterie supplementaire
mit zusaetzlichen leitungen
with supplementary hoses
con tuberiassupplementarias
inclusief extra functies

	A		B		D		E	
	mm	ft	mm	ft	mm	ft	mm	ft
F65AK.21 / F65AK.22	1905	6'3"	625	2'1"	2235	7'4"	735	2'5"
F80AK.21 / F80AK.22	1970	6'6"	615	2'0"	2190	7'2"	815	2'8"
F95AK.21 / F95AK.22	2190	7'2"	765	2'6"	2310	7'6"	845	2'9"
F110AK.21 / F110AK.22 / F110AK.23	2200	7'3"	755	2'6"	2235	7'8"	895	2'11"
F130AK.21 / F130AK.22 / F130AK.23	2220	7'3"	665	2'2"	2390	7'10"	970	3'2"
F150AK.21 / F150AK.22 / F150AK.23	2220	7'3"	665	2'2"	2390	7'10"	970	3'2"

	STD		EXTRA		IPEREXTRA		SUPEREXTRA	
	mm	ft	mm	ft	mm	ft	mm	ft
F65AK	3300	10'10"	4600	15'1"	5600	18'4"	5000	16'5"
F80AK	3365	11'0"	4505	14'9"	4975	16'4"	5600	18'5"
F95AK	3925	12'11"	4635	15'2"	-	-	5465	17'11"
F110AK	4425	14'6"	5535	18'2"	-	-	-	-
F130AK	4375	14'4"	5840	19'2"	-	-	6200	20'2"
F150AK	4375	14'4"	5840	19'2"	-	-	6200	20'2"

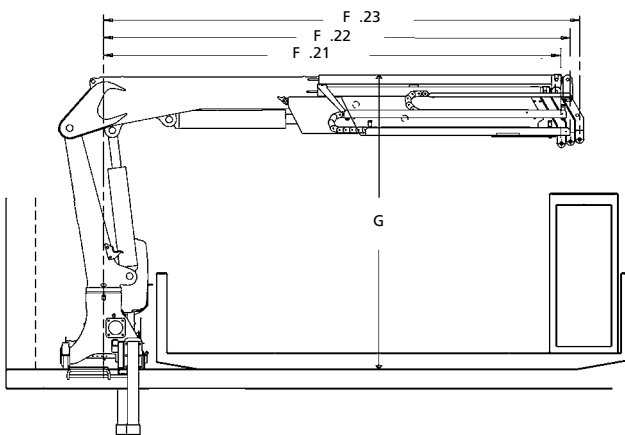

	.21		.22		.23		
	mm	ft	mm	ft	mm	ft	
F	F65AK	3550	11'7"	3615	11'10"	-	
	F80AK	3680	12'0"	3760	12'4"	-	
	F95AK	3680	12'0"	3760	12'4"	-	
	F110AK	4025	13'2"	4120	13'6"	4185	13'9"
	F130AK	4030	13'2"	4110	13'5"	4190	13'9"
	F150AK	4030	13'2"	4110	13'5"	4190	13'9"
G	F65AK	2300	7'7"	2385	7'10"	-	
	F80AK	2633	8'8"	2745	9'0"	-	
	F95AK	2575	8'5"	2615	8'7"	-	
	F110AK	2536	8'4"	2536	8'4"	2643	8'8"
	F130AK	2486	8'2"	2486	8'2"	2591	8'6"
	F150AK	2486	8'2"	2486	8'2"	2591	8'6"

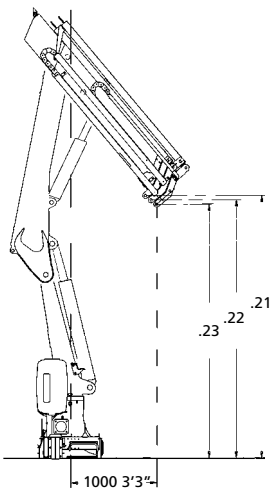

	.21		.22		.23	
	mm	ft	mm	ft	mm	ft
F65AK	2765	9'1"	2680	8'10"	-	
F80AK	2570	8'5"	2475	8'1"	-	
F95AK	3300	10'10"	3195	10'6"	-	
F110AK	2814	9'3"	2705	8'10"	2633	8'8"
F130AK	3099	10'2"	3010	9'11"	2920	9'7"
F150AK	3099	10'2"	3010	9'11"	2920	9'7"



Dati e dimensioni sono forniti a titolo indicativo e non impegnativo - Toutes les données et descriptions sont fournies à titre indicatif, sans engagement - Unverbindliche Angaben, Konstruktionsänderungen vorbehalten
Data and descriptions are approximate and not binding - Datos y descripciones todos a título indicativo y no imperativo - Specificaties zijn niet bindend, wijzigingen derhalve voorbehouden



FASSI GRU S.p.A. - Via Roma, 110 - 24021 Albino (Bergamo) ITALY
Tel- +39 035 776400 - Fax +39 035 755020
<http://www.fassigroup.com> E-mail: fassif@fassigroup.com

